

# ELECTRONEWS

**Sem-II**



## INSIDE THE ISSUE

Workshops	2
Activities	2
Clubs of department	2
Project details	2
Guest Lectures	3
Quiz Competition	3
Publication Details	3
Training and internships	3
Project Details	3
ICT Activities	3
Faculty Orientation Workshops	3
Patent Details	3
MOUs	4
Placement Details	4
Toppers	4

## INSTITUTE VISION

*To strive for excellence  
by providing quality  
technical education &  
facilitate research for the  
welfare of society.*

## HOD MESSAGE

*We are pleased to share the news through this newsletter in the Department of E&TC over the past few months. This newsletter records all the activities of department for one semester .We as a whole will strive to enhance our technical leadership in key areas and to build up strategic research areas viz., robotics, Artificial Intelligence and Machine learning. In terms of academic modules, we will continue to enhance and adapt our curriculum to cope with the rapid advances and development in technology in order for our graduates to be ready "to take on the world". My profound thanks to the editor and team of this newsletter for their initiative and interest in publishing it. I look forward to the support of our students, colleagues, and alumni, to work together to take our department to the next level! More importantly, I hope this will be a department we will all take pride in!*

## ABOUT THE DEPARTMENT

*The Electronics & Telecommunication Department is established in the Year 2013 to meet the needs of increasing demands of E&TC and Embedded Technologies & VLSI. The department is having highly qualified, experienced & dedicated staff along with State of Art Infrastructure & well equipped Labs. The teaching learning process is made Student centric using the latest technologies. The academics go hand in hand with Guest Lectures by Eminent Personalities from the Industry, Alumni students, & Subject Experts from Pune University. The theory is well explained with the help of practical & Industrial Visits to various Industries.*

## MISSION

1. To educate students with strong fundamentals by providing conducive environment.
2. To inculcate research with creativity & innovation.
3. To promote industry-institute collaboration & prepare students for life long learning in context of technological change.
4. To strengthen leadership, team-work, professional & communication skills and ethical standards

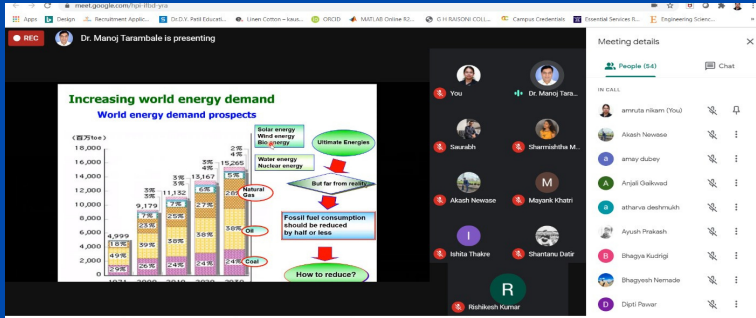

**Subject: Report on Webinar "Electric and Hybrid vehicle" held on 04/12/2020 in E&TC Department**  
**Name of the Guest: Dr.Manoj Tarambale**  
**Academy: Associate Professor, Electric department Engineering, MM college of Engineering, Pune**  
**Topic: "Electric and Hybrid vehicle"**  
**Day: Friday**  
**Date: 04/12/2020**  
**Time: 3.00 p.m. to 4.00p.m.**  
**No. of Students attended: 54**  
**Coordinator - Mrs. Amruta Nikam**

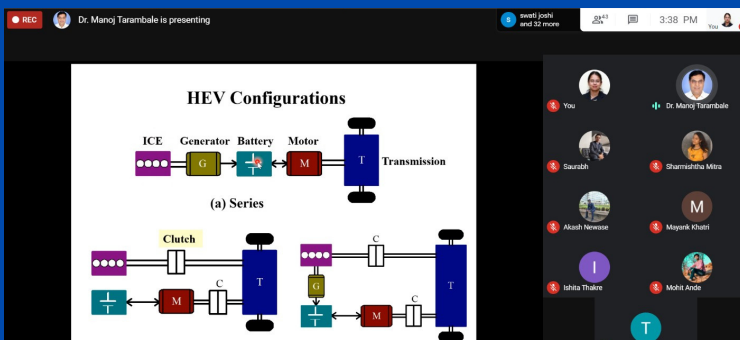

**Event was conducted by Mr. Santhosh Sir regarding GATE preparations.**

**How Well Do They Pay ?**

<b>PGCIL</b> ₹ 14.9 LPA	<b>BPCL</b> ₹ 14.2 LPA	<b>RITES</b> ₹ 11.8 LPA	<b>EIL</b> ₹ 11.4 LPA
<b>IOCL</b> ₹ 11.3 LPA	<b>ONGC</b> ₹ 11 LPA	<b>NALCO</b> ₹ 10.9 LPA	<b>NTPC</b> ₹ 10.7 LPA

Average Salary of the PSUs is between 6 to 8 LPA

**Probable Cut-Offs**

	<500	500-800	800-1500	1500-3000	3000-6000	>6000
PSU & Jobs	✓	✗	✗	✗	✗	✗
M.Tech in Old IIT	✓	✓	✗	✗	✗	✗
NITIE	✓	✓	✗	✗	✗	✗
M.Tech in Top NITs	✓	✓	✓	✗	✗	✗
M.S in Top IITs	✓	✓	✓	✓	✗	✗
M.Tech in Top new IITs	✓	✓	✓	✓	✓	✗
M.Tech in other IITs and NITs	✓	✓	✓	✓	✓	✗
Direct PhD in Top Col	✓	✓	✓	✓	✓	✗
Foreign University	✓	✓	✓	✓	✓	✗
HRF & Other Colleges	✓	✓	✓	✓	✓	✗

Handwritten notes: "GME Rank" and "Junior Research Fellow RA".

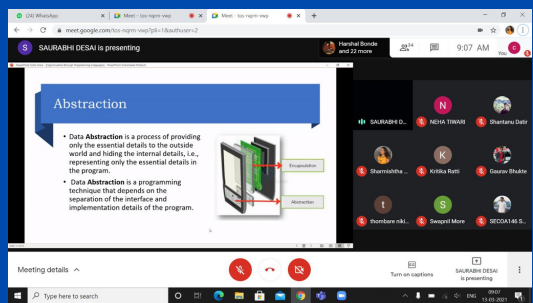
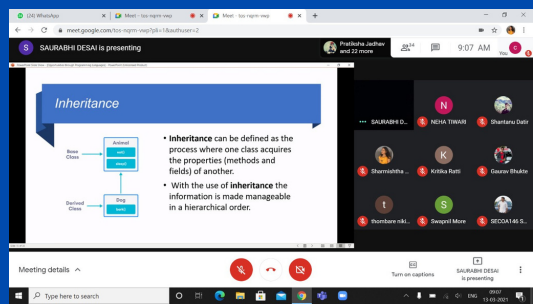

**Guest Lecture on the OOPS concept by Miss Sourabhi Desai Alumni of DYPIEMR.**

# WEBINAR'S

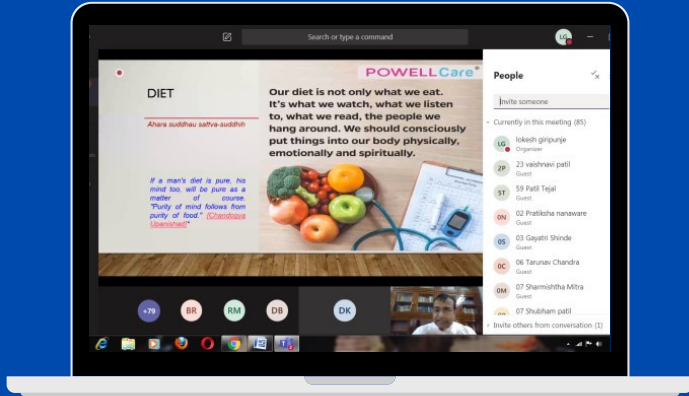

*The session was organized by IEEE student branch of E&TC department on 29th June, 2020 at 11am. The session was conducted by Dr. Sudipta Roy, Holistic Homeopath, Wellness adviser, Medical researcher, MD-Powell group of companies*



*Project Competition was conducted for all TE and BE students from 05/06/2020 to 10/06/2020 in DYPIEMR (Online Platform) under IEEE activity. This program was conducted for all colleges. Total 93 students registered for this competition. External college faculties were called as judge for this event. 3 Winners were declared from TE and BE groups. Certificates were distributed to all the participants.*

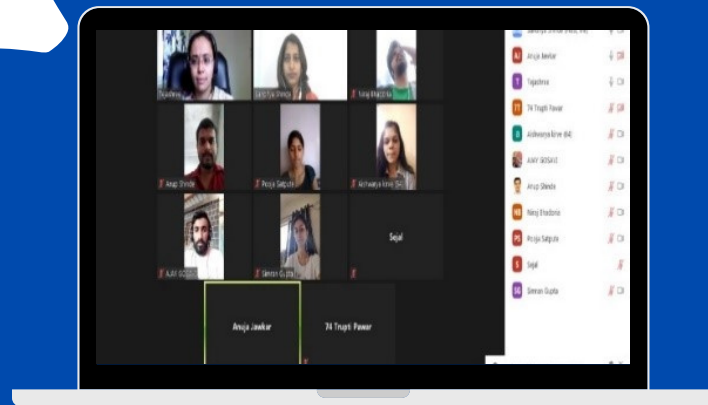

*Webinar conducted on "How Pranic healing helps in study and day to day life" for SE ,TE and BE students on 17/06/20. The objective of webinar to make students stress free during lockdown. It was conducted by Ms..Roshni Hande (Counsellor &Pranic Healing Instructor).*

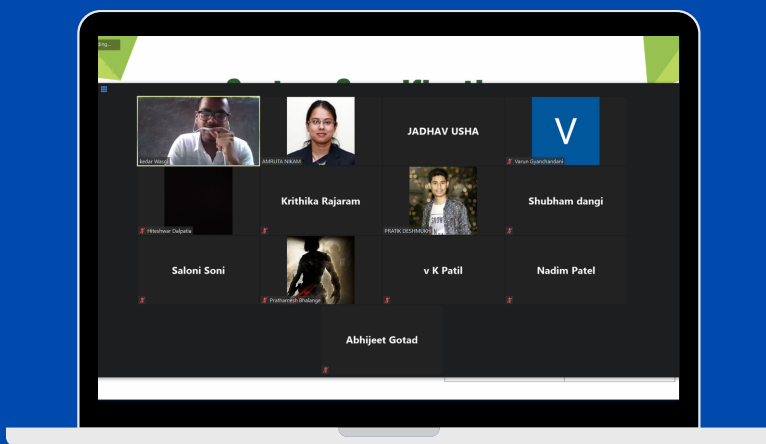

# BEST ACTIVITIES



## Webinar on “Quadcopter Basics & Applications”

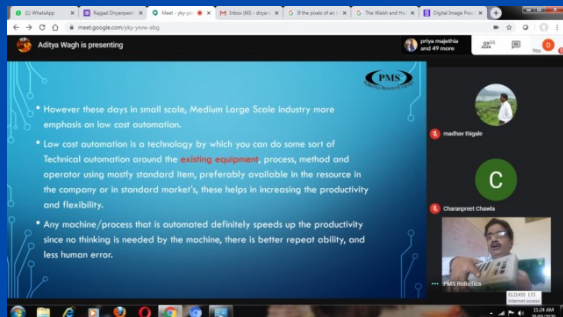
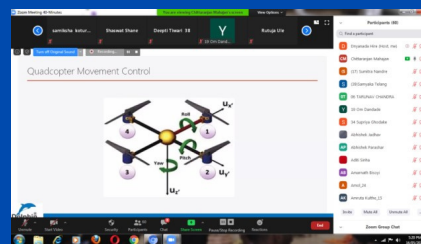

## Webinar on “Industrial Robotics & Low-cost automation solutions”

## Webinar on “Computational Electromagnetics Techniques using Altair FEKO + Win prop”



## Social Activity Conducted in Nachiket Balagram by showing Video on “Safety Measures during COVID-19”

## Making and distribution of Safety Face Mask to the needy.



## CodeOVID Competition



# ACHIEVEMENT'S



- Emerging Career Opportunities post Covid-19 Pandemic-A Session for Graduate Aspirants



- MHRD AICTE MEGA ONLINE CHALLENGE "SAMADHAN" Restarts of educational Institutes after covid -19 lockdown

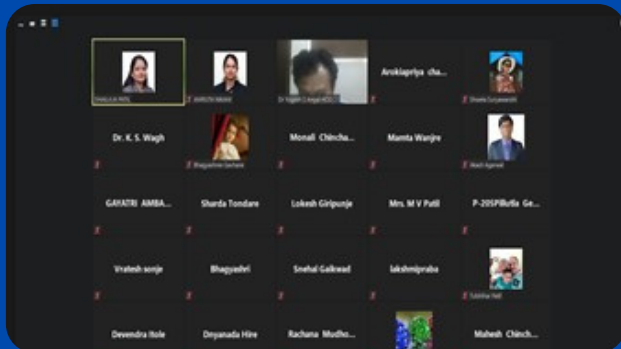

- Webinar on Unveiling Intellectual Property Right

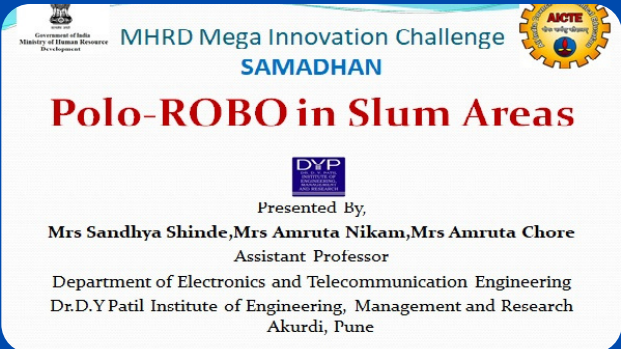

- MHRD AICTE MEGA ONLINE CHALLENGE "SAMADHAN" POLO Robo in Slum area



- MHRD AICTE MEGA ONLINE CHALLENGE "SAMADHAN" Doctors friendly isolation ward system



- "Cut Camera Capture"

